

CILINDRO PRENSOR SIMPLE EFECTO ANTIROTACIÓN
SINGLE ACTING NON ROTATING CLAMPING CYLINDER



CILINDRO PRENSOR SIMPLE EFECTO ANTIROTACIÓN

Single acting non rotating clamping cylinder



CÓDIGOS

Order Code

RJ	35	C	0070
Modelo Model	Diámetro interior Inner diameter	Versión Version	Carrera Stroke
RJ Cilindro prensor simple efecto antirotación Single Acting non rotating clamping cylinder	35	C Tipo corto Short Type	70
		L Tipo Largo Long Type	115
	40	C Tipo corto Short Type	75
		L Tipo Largo Long Type	115



Leyenda
Legend

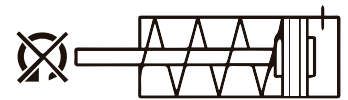

Ejemplo Código Cilindro prensor simple efecto antirotación Ø35 carrera 70 Tipo corto
Order Code Single Acting non rotating clamping cylinder Ø35 Stroke 70 Short Type

COD: RJ 035 C 0070

CARACTERÍSTICAS TÉCNICAS

Specifications

Características técnicas Specifications	Ø35	Ø40
Fluido Fluid	Aire filtrado, lubricado o sin lubricar Filtred lubricated or not lubricated air	
Conexión Connections	G 1/8"	
Presión de trabajo Working pressure	2 ~ 10 bar	
Temperatura ambiente Working temperature range	-10 + 60°C	
Material vástago Rod material	Acero cromado Chrome plated steel	
Material perfil Tube material	Aluminio anodizado Anodized aluminium	
Material juntas Seals material	NBR NBR	
Fuerza de trabajo (6bar) Thrush force (6bar)	600N	800N
Peso [gr] Tipo: Corto/Largo Weight [gr] Type: Short/Long	580/680	600/700

CILINDRO PRENSOR SIMPLE EFECTO ANTIROTACIÓN

Single acting non rotating clamping cylinder



Cilindro prensor simple efecto antirotación
Single acting non rotating clamping cylinder

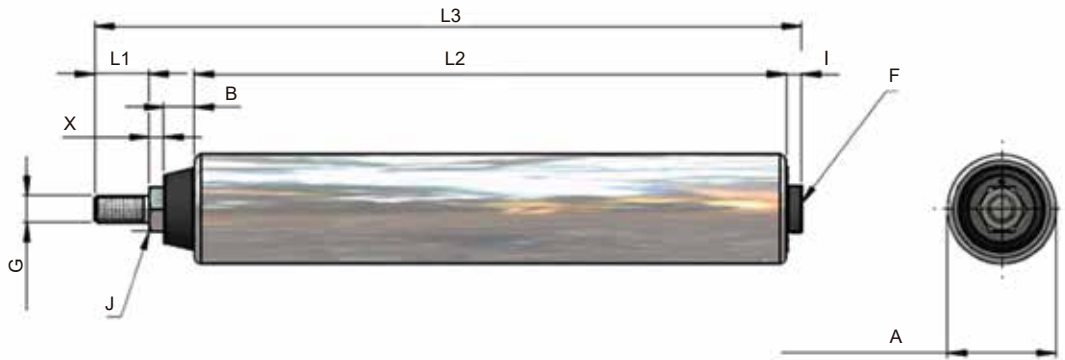

Código Code	Ø	Carrera Stroke	A	B	F	G	I	J	L1	L2	L3	X
RJ035C0070	35	70	40	12	G1/8"	M10	6	16	20	135	180	5
RJ035L0115	35	115	40	12	G1/8"	M10	6	16	20	220	260	5
RJ040C0075	40	75	45	12	G1/8"	M10	6	16	20	145	190	5
RJ040L0115	40	115	45	12	G1/8"	M10	6	16	20	220	260	5

ACCESORIOS Y FIJACIONES

Fixing and Accesories

Topes plastico roscado en eje del cilindro
Plastic pads to screw on the cylinder rod

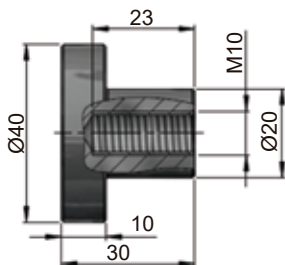

Código Code	RJ00000003
-------------	------------

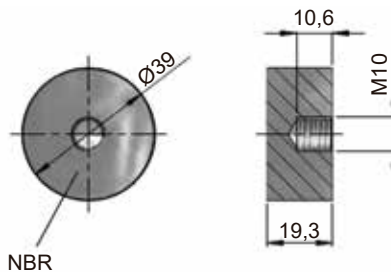

Código Code	TPN00009
-------------	----------

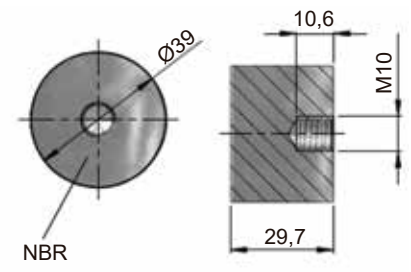

Código Code	TPN00010
-------------	----------

Soporte para cilindro prensor
Vice with lever locking

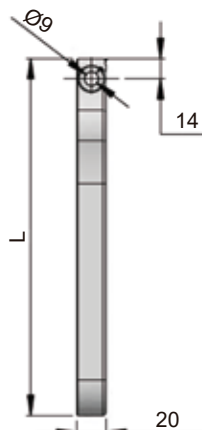
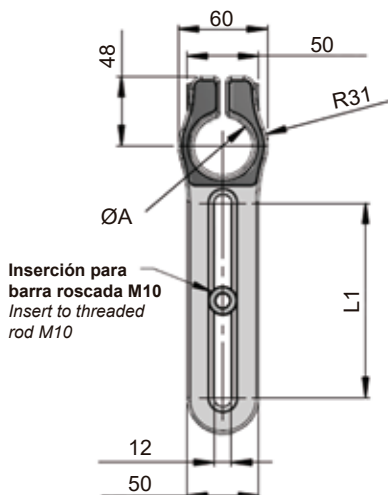

Código Code	Ø cilindro	Tipo Type	L	L1	A
KCL00247	35	Corto / Short	193	80	40
KCL00248	35	Largo / Long	248	135	40
KCL00249	40	Corto / Short	193	80	45
KCL00250	40	Largo / Long	248	135	45

■ Para más artículos contactar con dpto. comercial

■ Ask form more items to our Sales Department



García Marín System, S.L.

Tel.+34 93 785 42 45

gm@gmsystem.net · www.gmsystem.net

P.I. Can petit c/Puigbarral nº34 nave i
08227 Terrassa - Barcelona (Spain)